

Article number: 25018462002

Description: ICME Single-phase motor MD63 B4 0,18KW  
4 - 1400 rpm 1x230 Volt 50Hz B3 with starting & running capacitor

## Measures

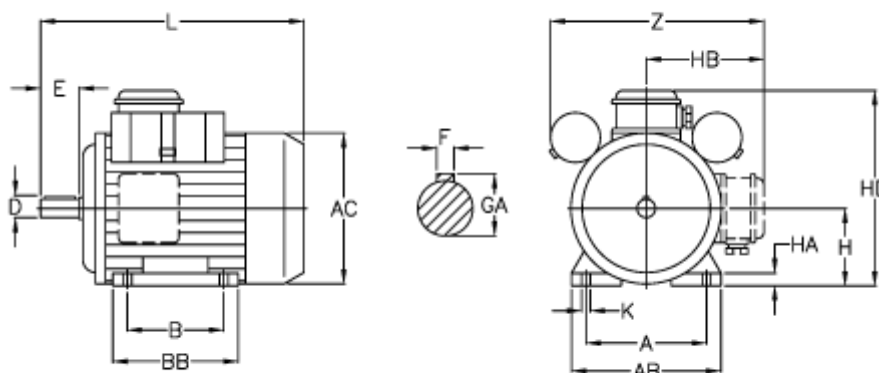

A = 100	H = 63
AB = 126	HA = 10
AC = 124	HB = 98
B = 80	K = 7
D = 11	L = 241
E = 23	Z = 170
F = 4	
GA = 12.5	